

# FENDT

Fendt Tigo forage wagon (PR/XR)







## Flexible. Compact. Robust. Fendt Tigo XR and PR.

Ultimate in feed quality. Vast loading space. Quick unloading. The forage wagons Fendt Tigo PR and XR meet these requirements. The multifunctional bulkhead with VarioFill gives you another 6 m<sup>3</sup> for impressive loading volumes. Whether silage or hay: Automated loading with continuously adjustable pre-compacting pressure makes the most of every cubic metre and actively supports the unloading process. The end result is that a clean, emptied trailer and top quality feed.





## Safely on track. A comfortable ride.

With the Fendt Tigo, you're always right on track, either on low-lying land, on the roads or on difficult terrain. Whatever the slope, with Fendt Stability Control (FSC) the vehicle is always kept level. Its stability is impressive, even when taking corners, You feel the safety and the singular drive comfort with each load.

		TIGO 45 PR	TIGO 50 PR	TIGO 60 PR	TIGO 70 PR	TIGO 65 XR	TIGO 75 XR	TIGO 90 XR	TIGO 100 XR
Volumes in accordance with DIN 11741	m <sup>3</sup>	31	31	36	41	38	44	50	54
Permissible overall weight*	kg	17.000/18.000	20.000/22.000	20.000/24.000	20.000/24.000	22.000/24.000	24.000/31.000	31.000	31.000

\* = specific to the country



**100 percent use, always.**

Whether a loading wagon or a forage carting, the Fendt Tigo always gives its all. You work efficiently, flexibly and harvest without any loss of quality with the versatile Fendt Tigo. It is the ideal combination of compactness and innovation. It wins you over with effective arguments:

- High loading volume of 31 m<sup>3</sup> to 54 m<sup>3</sup> (DIN) in a lightweight and compact design
- Adjust the downward pressure on the feed onscreen
- 80 ° pivoting multi-functional bulkhead with VarioFill
- Small distance between pick-up and cutting rotor
- Direct, maintenance free and durable oil bath drive
- Parallel ISOBUS operation using the drive lever, Varioterminal and loading vehicle terminal
- You can opt to have the Tigo XR steer the tractor, with the TIM ready feature (Tractor Implement Management)
- Optional extra-wide, hydraulic high-performance pick-up available
- Available with FlexSharp knife sharpener
- Always ready as a loading wagon and harvest transport vehicle without any conversion effort



**The perfect team = Fendt Vario + Fendt Tigo**  
Together, both these machines form the team with best efficiency and payload. While the Fendt Vario tractor is impressive with its high payload owing to the intelligent lightweight design, the Fendt Tigo forage wagon is the best companion – light to tow and compact. This vehicle is a whole metre shorter than its competitors thanks to the revolutionary bulkhead. With its TIM ready function (Tractor Implement Management) the Fendt Tigo XR steers according to the output and speed of the Fendt Vario. It's the perfect team.

Fendt Tigo XR and PR.  
100 percent use, always.



## FEED UP-TAKE AND PICK-UP

# Fendt Tigo: Lifts you to the next level of harvesting technology.

### Optimum pick-up power with extended pick-up

The advanced pick-up of the Fendt Tigo makes your forage wagon more efficient. The Fendt Tigo has seven rows of tines and a width of 1.90 m (PR) / 2.20 m (XR), for clean raking results. The small diameter of the pick-up gives the tines a high peripheral speed. The pick-up is close to the rotor on the Fendt Tigo – for a fluid and clean crop flow. This gives you excellent raking performance and feed delivery to the cutting rotor even with short, dry grass. The Tigo XR comes with a hydraulic pick-up drive as standard. The Tigo PR offers the option of a hydraulic, extra-wide pick-up with a working width of 2 metres. This is fitted with a maintenance-free, chain-less drive with continuously variable speed settings. Top-class efficiency.

### All under control!

The drawbar position control of the Fendt Tigo takes care of an accurate loading position control. A sensor measures the pick-up movement and readjusts the drawbar. The advantage for you? A consistently constant feed opening and full crop flow even at high road speed.

### Preserve the sward with perfect ground following

The sensing roller protects the pick-up against piercing in the ground through clear guidance. It maintains the appropriate ground clearance even in hard and uneven ground conditions and skates around the dirt. Thanks to the intelligent technology, it provides support only when necessary and does not run permanently. You can individually set the sensing roller depending on the harvest conditions. Apart from optimum feed quality, the Fendt Tigo also takes care of soil protection. The adjustable, castor-steered gauge wheels support the pick-up and also protect the sward even when making tight turns in the field.

### Smooth results

A successful harvest all comes down to the best possible pick-up. To help with this, the Fendt Tigo features plastic strips between the pick-up tines. In wet or dry conditions, the plastic keeps the friction low and the individual wrappers are less prone to contamination. Both cleanliness as well as efficiency are of importance in Fendt Tigo. For this, the roller pressure pad evenly presses on the swath and simultaneously supports the conveyor effect of the pick-up. The interplay of the roller pressure pad with the strip plate from the individual metal rods reduces the friction and secures a smooth crop flow.

A constant contact pressure is guaranteed with the integrated hydraulic pick-up release system. The improved ground contour preserves the pick-up and the turf. You can choose to fit the system at a later date.



The trailing feeler wheels of the advanced pick-up release it on corners and can be turned. Adjust the height of the wheels with a series of holes.



The 7 tine rows, with 54 mm between each tine, are surrounded by solid plastic strips. The interplay guarantees the best raking performance and crop flow thanks to the low frictional losses.



The pick-up, placed centrally behind the sensing roller, constantly maintains the set ground clearance and guarantees safe guiding of the pick-up even on hard ground conditions.

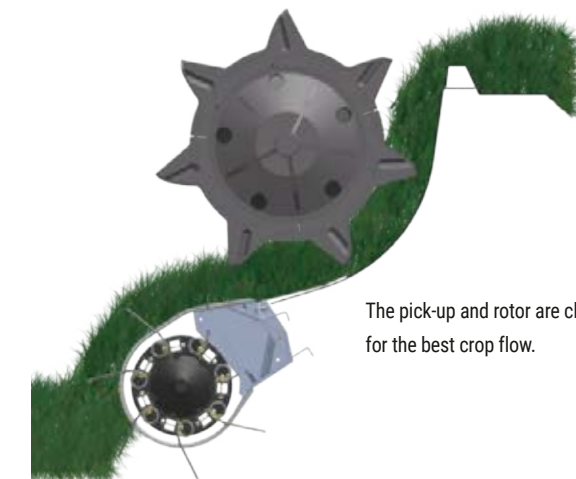

The pick-up and rotor are close together for the best crop flow.



## ROTOR AND DRIVE

# Exciting efficiency: the Fendt Tigo makes the difference.



The rotor teeth are divided into three elements and can be removed individually. Three new elements are locked for simple replacement and then welded three times with individual locks.

### A convincing performer

The rotor of the Fendt Tigo impresses with its strength and huge output. With a cutting gap of just 3.5 mm – the smallest on the market – and the 25 mm wide rotor tines with Hardox contact surfaces, the Fendt Tigo stands out from the crowd with its quality of cut. The grass is fed exactly through the narrow cutting gap and has no alternative way out. It is actively conveyed through the table while the seven spiral rows of tines provide for an efficient, precise cut. With a feed channel of more than 1 m<sup>2</sup>, the feed is carefully carried to the loading space even under difficult operating conditions. You thus achieve a precise quality of cut without crushing and optimum quality pre-compacted feed.

### Are you still waiting to switch on or are you already on the move?

You save time and money with Fendt Tigo. The patented solution for replacing individual rotor segments, means nothing flusters you any longer. Thanks to the innovative design, you replace only the individual rotor teeth in case of damage by foreign object or wear. The T-shaped, 25 mm wide contact surface of the rotor segments guarantees high stability. At the same time, the Fendt Tigo develops more thrust with little effort.

### Precision, right on the mark

Grass harvest, no problem – the Fendt Tigo guarantees you optimum output. The perfect interplay between pick-up and rotor result in an ideal crop flow and highest loading performance. The transfer point of the pick-up is close to the cutting rotor. The crop therefore travels only a short way from the feed to the rotor. Thanks to the shorter design and low peripheral speed of the rotor, you achieve optimum raking performance and feed transfer even with short, dry feed. This allows you to work preserving the feed to give outstanding quality.

### Efficiency is equal to output

The more effective the power flow of a gearbox, the higher the generated output. Achieve optimum performance potential with the unique propulsion system of the Fendt Tigo. The maintenance-free high-performance gearbox integrated in the chassis suspension frame runs in the enclosed, permanent oil bath and is extremely smooth. The outstanding smoothness takes the strain off the operator and provides a comfortable working environment. Contamination of feed due to dripping chain lubricants is also impossible. Combined with the extremely wide pick-up of the Tigo XR, the torque protection of the drive is 3,000 Nm. This corresponds to a formidable power increase of 25%.

The power of the main drive is conducted from the feeder shaft to the drive stump of the cutter rotor by extra strong spur gears with a force-fitting involute teething.

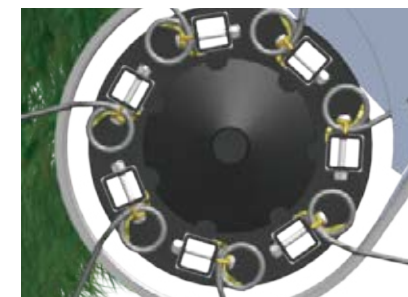
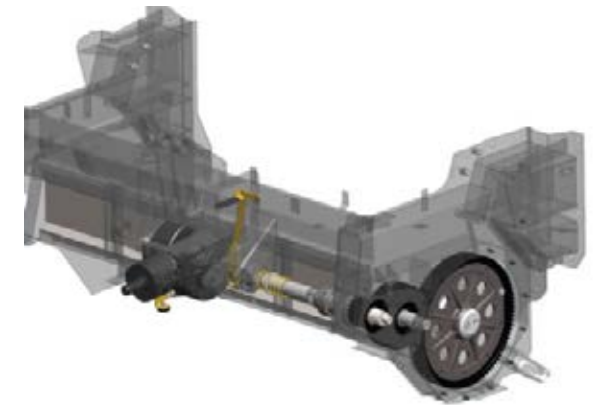

The synchronised peripheral speed allows the pick-up to bridge the gap to the rotor at a low, gentle speed.



To protect the rotor against corrosion and contamination when working with maize, the Fendt Tigo has a maize channel cover that can be fitted quickly and without tools.



With a diameter of 800 mm and 7 spiral tine rows made of Hardox steel, the rotor is equipped on both sides with large spherical roller bearings.



## KNIVES AND QUALITY OF THE CUT

# Maximum cutting performance from the first to last blade.



The elongated knives with serrations on one edge ensure an efficient, pulling cut, and can be removed without the use of tools.

### High-performance table

The better the quality of the cut, the better the compression, fermentation and forage digestion. The combination of a large number of knives (PR=40, XR=45), a pulling cut and the 3.5 mm small gap between the knives, guarantees a clean-cut forage bundle. The Fendt Tigo uses elongated knives made of hardened tool steel with a special serrated edge. This prolongs the service life of the Tigo and cuts along the entire length to produce the best quality silage. The necessary flexibility is provided by the easy cutting length adjustment. The tool lever can be used to effortlessly half the number of knives, and to change the cutting length from 37 mm to 74 mm.

### Reliability thanks to Trimatic

Each knife is protected by a separate single knife guard with the unique impact guard system. If the rotor pushes a foreign object onto the knife, the spring buckles and immediately reduces the force onto the knife. This tension automatically returns the knife to its operating position after the foreign body has passed through. The innovative spring-based trigger system protects the knives and rotor, and guarantees constant functionality even in the harshest of operating conditions.

### Easy maintenance

The aim is to make work as easy as possible for you. The combi wagon guarantees quick and easy handling through its knives which can be removed without the use of tools. Move the table bars from the operating to service position from the comfort of your terminal or by pressing the buttons on the side. It's easy to change the knives by swinging the knife frame to the side. Each knife can be unlocked by the central knife release, and removed individually at each point in the frame.

### FlexSharp knife sharpener

For even better efficiency and quality of cut, the Tigo comes with the option of a FlexSharp knife sharpener. This optional mobile knife sharpener is compatible not just with your Tigo but your entire fleet of loading wagons, Fendt round baler knives as well as non-Fendt machines. The device is simply carried in the trailer and the knives are sharpened in the loading wagon itself, without removing them one-by-one for sharpening. A sure investment. Sharp knives reduce your fuel consumption while improving the quality of the cut and the all-important quality of the base feed. To power the sharpener, the Tigo XR and PR comes with the hydraulic hoses already set up.

The springs on the Trimatic single knife protection guarantee efficient and effective protection against foreign objects for both the knives and rotor.



The table frame is sub-divided into 2 groups, so you can easily switch between a cutting length of 37 mm and 74 mm or no cut.



Use the FlexSharp knife sharpener to sharpen the knives without removing them.





## DESIGN AND LOADING SPACE

# Everything under control with Fendt Tigo.

### Stay on top of things

The similarity of the front side of Fendt Tigo with a trough has a very specific reason. The operator always has a perfect view in the loading space through the forward sloping body design. With loading capacities of 31 m<sup>3</sup> to 41 m<sup>3</sup> (DIN) for the PR models and 38 m<sup>3</sup> to 54 m<sup>3</sup> (DIN) for the XR models, you can transport your crop quickly and efficiently.

### Robust and stable

The Fendt Tigo ensures maximum stability and lifetime. The robust and solid all-steel body with closely-packed side stanchions is directly screwed together with the chassis frame and the profile frame bolted above. This makes it the most stable and the most compact loading wagon of its class.

### Simple and without alterations

Versatility and maximum operational flexibility are the deciding factors for maximum economic viability. With the Fendt Tigo, you can quickly and easily switch from loading to chipper wagon without any major adjustments. The structure of the forage wagon was designed without tubular frame or tensioning rope, making it ideal for filling with the chopper from above and from the front. At the end of the day, you profit from the low feed losses, high flexibility and fast operational readiness.

You can easily reach into the interiors of the Fendt Tigo. The boarding door on the side with integrated stair can be easily opened without much effort.



Thanks to the completely closed bulkhead, no crop is lost even when chaffing maize. All without changing a thing.



Secure your load during road transport with the matching cover. This prevents the serious safety risk of leaving dirt and debris on the road.



The Fendt Tigo is designed without a tubular frame to allow simple filling from above, whether using the bucket or the chopper.



The hydraulic loading space cover is easy to operate via the terminal.



AUTOMATIC LOADING AND BULKHEAD

# The Fendt Tigo makes light work of grass and maize.



The smart VarioFill automatic loading and unloading system makes the best use of every cubic metre of the Fendt Tigo.

**The first component of VarioFill is the bulkhead**  
 More compact, easier, more manoeuvrable and shorter by at least 1 meter than other loading wagons in its class. With its 80° pivoting multi-functional bulkhead, the Fendt Tigo is one of a kind when it comes to loading. The space above the loading unit creates 6m³ more volume but keeps the vehicle short. The completely closed frame of the bulkhead offers maximum stability in turn. The Fendt Tigo is the payload champion – with its weight-saving and compact dimensions. Combined with the Fendt tractor, it becomes an unbeatable team. Enjoy better road positioning during transport with ideal weight distribution and optimum hitch load.

**The second component of VarioFill is the automatic loading**

Always exercise the right pressure with the Fendt Tigo. With the bulkhead acting both as a loading and feeding wall, plus integrated automatic loading and unloading system, every cubic metre of the loading volume is put to best use. Adjust the 2-step automatic loading and continuously adjust the compression pressure of the feed from the terminal. The pre-compacting pressure can be customised optimum to the feed structure with this unique system. Whether it is higher pressure for a maximum loaded wagon or lower pressure to avoid crumbling losses in hay – as soon as the selected compression pressure is reached in the pressure sensor of the hydraulic cylinder, the scraper floor automatically sets itself in motion. If the complete loading space is filled, the bulkhead moves gradually forward. You take maximum advantage of the loading capacity with the VarioFill and work efficiently and preserving the feed.

**The third component of VarioFill is the automatic unloading**

Manual removal of feed residues at the end of the day is not required. The VarioFill makes the unloading a relaxed affair. The unloading process starts with pressing a button. The trunk lid is opened and then the scraper floor and the bulkhead start simultaneously. The multifunctional wall gently pushes the feed stock through the declining movement and reduces the load of the scraper floor chains. The bulkhead presses the last feed wedge actively to the scraper floor through the arching position arising in the end position and ensures that the vehicle is properly emptied.

The manual operation of the scraper floor no longer becomes necessary with the VarioFill automatic loading and unloading; you can sit back in the cab and just steer.

Your forage wagon is always optimally loaded with the continuously adjustable compression pressure.

The VarioFill automatic unloading creates more efficiency in your operation. The entire process is started by pressing just one button.



VarioFill: The combination of intelligent automatic loading and unloading and, multifunctional bulkhead.



## LOADING SPACE AND SCRAPER FLOOR

# The Fendt Tigo leaves nothing to chance.

### The right angle

The Fendt Tigo guarantees easy and efficient loading and unloading, without the feed having to be pushed up into a forage channel, as the scraper floor is lowered by 250 mm. The forage wagon precisely sets its power. The perfect arrangement of the conveyor elements means less power is required while loading, which, in turn, means less fuel is consumed.

### The right speed

You can keep calm even in hectic situations with the forage wagon. The hydraulic 2-step scraper floor drive on the XR, optionally even in PR, can be adjusted depending on the crop and weight. The continuously adjustable form feed speed guarantees you the fastest possible emptying. If you are pressed for time, you can engage 'rapid feed' to unload up to a faster and even more efficient 25 m/min. The Fendt Tigo is additionally equipped with a scraper floor return for the models with feed rollers. This drive sets you up for even the toughest tasks.

### The right distribution

A consistent crop output while unloading improves the performance while compacting in the silo. You can create a uniform blanket of feed on the silo with the high-performance profile of the closed feed rollers. Grass, maize or even whole plant silage are meticulously separated from the feed stock. The Fendt Tigo ensures such a precise unloading process. The powerful spur gear with the large drive chains guarantees a smooth drive. In order to keep the system streamlined, the drive train shafts are enclosed in the frame. The simple design of the rollers towards the rear gives you the flexibility of 2 m<sup>3</sup> more loading space.

Armed for the toughest jobs – the Tigo XR's flat link chains with 60 t breaking load. The Tigo PR supports you with strong, durable round steel chains with a breaking load of 50 t.



Starting from Tigo 75 XR, there is the two-sided scraper floor operation by standard for safe unloading of high masses.



The galvanized, lowered steel floor provides the optimum anti-corrosion protection against everything during transport of maize silage.



All wagons in the Tigo PR and XR series can be supplied either with 2 or 3 feed rollers. For more load volume, the individual rollers can be simply extended towards the back.



When the feed pressure is reached on the lower feed roller, the motion sensors stop the scraper floor feed automatically.



SERVICE MEETS FRIENDLINESS

# Intelligent technology. Simple operation.

### Fendt Tigo XR takes over the controls

With TIM (Tractor Implement Management), the flow on the Fendt Tigo XR can now be fully automated. The combi wagon regulates the driving speed of the tractor to suit the pick-up volumes. Depending on the swath strength, a speed sensor sends ongoing feedback on the torque at the pick-up. With TIM ready, the Tigo XR and Fendt Vario team self-adjusts for constant productive results. This smart assist is also a great help for the driver, who can fully concentrate on the loading process.

### Unique system

The choice is yours! With the unique operating concept, you can configure all settings in parallel using 3 different options. Easily steer the loading wagon on the Varioterminal with ISOBUS or assign your main functions to the joystick of your Fendt Vario. The Fendt Tigo has the right feature for everyone.

### Easy, intuitive controls

The AUX-N ISOBUS functionality means the Tigo can be controlled with the joystick. This offers individual functions such as lifting the pick-up at the push of a button, which improves the ergonomics of the controls. With a Fendt Vario and Tigo hookup, you can assign up to 10 ISOBUS functions to the Variotronic multi-function joystick.

### No limits

The Fendt Tigo offers you the ultimate in flexibility and compatibility. You can steer the Fendt Tigo comfortably using the loading wagon terminal even with old tractors without ISOBUS. As soon as your new ISOBUS-capable tractor expands your fleet, you can change to the Varioterminal.

You can go to the loading and unloading menu and the general settings from the Start menu.



Control the bulkhead and the cutter unit on your terminal. Even the pick-up and drawbar can be conveniently adjusted from here.



With TIM ready, the Tigo XR can adjust the speed of the tractor according to the swath strength and pick-up capacity.

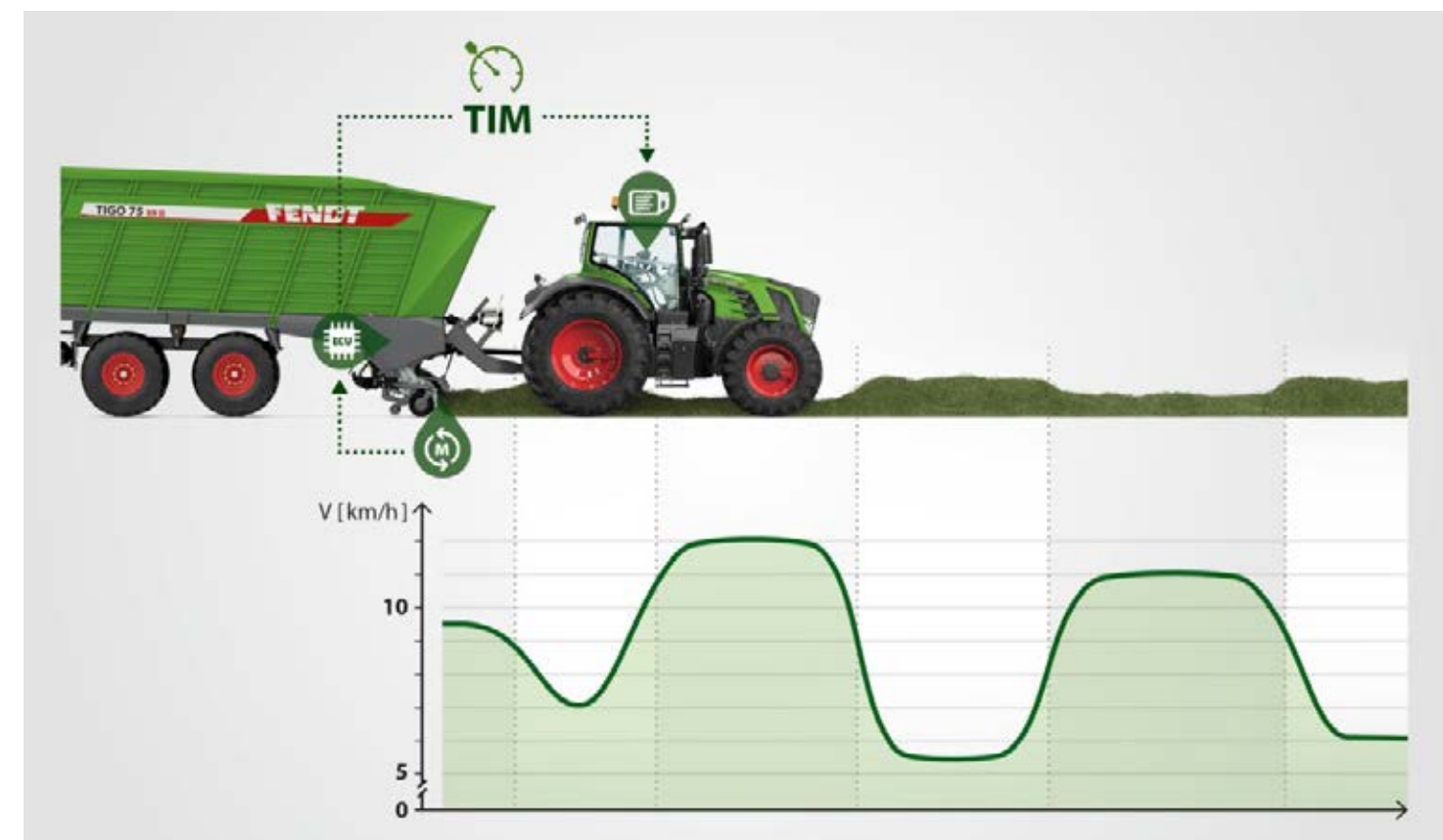

The table and scraper floor can be conveniently and easily operated directly on the loading wagon.



The weighing system optionally integrated at the hydropneumatic chassis suspension shows the crop yield to you comfortably in your cab. Thus, you maintain a constant control on the weight and the payload.



## CHASSIS AND CONCEPT

# The perfect chassis for maximum output.



The 60 km/h speed limit lets you get the best out of your hookup, and reach your destination quicker.

### Payload champion

The flexible and easy conversion of the loading wagon into a forage wagon makes the Fendt Tigo the right solution for your farm. Alongside grass and maize, this wagon is also ideal for transporting wood chippings and other loads. Whether on a large farm with its own equipment, a biogas plant operator, or contractor, there's something to suit everyone amongst the 7 combi wagon model variants. The combination of very high payload and dual use ensures that the capacity can be fully utilised, and enhances the return on investment in the Fendt Tigo. Components have been designed to be durable and extremely rugged to keep the Fendt Tigo operational at all times.

### Boogie tandem chassis

Regardless of the terrain on which you work, the standard tandem chassis of the Fendt Tigo PR provides optimised ground following. Heavy loads are distributed evenly and the high spring travel provides for a comfortable driving experience at a maximum weight allowed of up to 24 tonnes. Wide parabolic springs and few moving parts ensure exceptional lateral stability and minimal maintenance effort.

### Hydropneumatic chassis

With the Fendt Tigo XR you have a choice of support from a hydropneumatic (HPN) tandem or tridem unit. High loads are evenly distributed on both chassis, ensuring that the soil is well-protected. The hydropneumatic suspension with automatic levelling box provides you with the ultimate in ride comfort. The front and rear axles of the tridem chassis can be separately and actively controlled by the offset steering system. The HPN chassis can also be raised and lowered. The Fendt Stability Control (FSC) feature, fitted as standard, provides constant sway stability on corners, and keeps the loading area parallel to the slope.

### The stable chassis – Fendt Stability Control

Things get hectic during harvest time. There is a need for speed. In order that you can work efficiently and safely even on slopes, the Fendt Tigo offers an automatic levelling box thanks to the Fendt Stability Control (FSC). A downward or sideways slope which can pose a considerable risk with a full wagon, is compensated in the Fendt Tigo using the automatic levelling control. Complete spring travel is always available to the Fendt Tigo regardless of the load, and therefore ensures the ultimate in safety in the fields and on the roads.

The Tigo PR series comes as standard with a 20 tonne boogie tandem axle unit. The large-volume tyres provide a huge contact area which is exceptionally gentle on the soil.



All models can be fitted optionally with hydraulic or electronic forced steering. The efficient, smart drawbar design also allows a steering angle of 60° even with forced steering.



The hydropneumatic suspension with automatic levelling box provides the ultimate in ride comfort. If a bottom hitch with ball coupling is used, the Fendt Tigo 100 XR, or the Tigo 75 XR, can be operated with a maximum weight allowed of up to 31 tonnes.

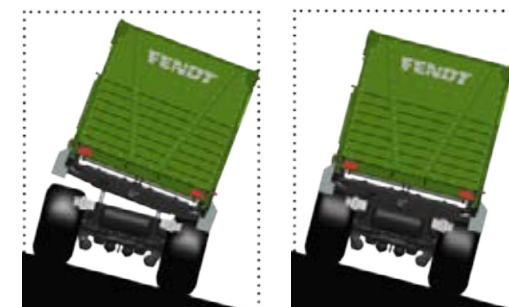

Without the automatic levelling control, the vehicle tilts downwards or to the side on slopes depending on the load and cornering speed (see Figure left). With the automatic levelling control from the FSC, the vehicle always stands parallel to the slope. The vehicle always adjusts to the best chassis height depending on the load (see Fig. right).



SUITABLE FOR ANY JOB

# The Fendt Tigo gives you the freedom you need.

### The right gap

So you can quickly move in and out of the field during harvest time, the Fendt Tigo offers a generous ground clearance of 80 cm. The high ground clearance is set at the touch of a button, and the drawbar swung out to its maximum extent, Meaning that even rough terrain is no problem, especially during the maize harvest.

### Full steam ahead

The hitches on the Fendt Tigo enable you to make best use of large loading volumes, and to load a bumper crop. The Tigo PR series is equipped as standard with a drawbar for a clevis-type hitch, which gives you a drawbar load of 2 tonnes. The Fendt Tigo XR comes as standard with a hydraulically sprung drawbar and bottom hitch with K80 ball coupling. The 4 tonne drawbar with hydraulically sprung drawbar on the Tigo XR is also available as an option for the Tigo PR. The streamlined drawbar design allows the maximum steering angle even with large tractor wheel treads.

### An adaptable steering system

With the hydraulic or electronic forced steering system with offset steering, each steering movement of the tractor is transferred to the trailer. The Fendt Tigo therefore allows you to reverse with active steering axes without locking them manually. It also improves road safety, as the loading wagon runs right on track behind the tractor and is prevented from swaying and swerving on turns and corners. The wagons are fitted as standard with a self-steering axle. The smart, streamlined drawbar design also allows a steering angle of 60° even in forced steering mode.

Raise the hydraulic drawbar for a ground clearance of 80 cm, even in transport position. This brings you safely to your destination by any route.



They are also available with hydraulic or electronic forced steering as an option.



The drawbar position control ensures that the set opening angle of the pick-up is automatically sustained and controlled. This guarantees an even and constant crop flow without constriction, and clean raking even in hilly terrain.



The drawbar suspension of the Fendt Tigo gives you even more ride comfort.





## FENDT SERVICES

# The best product with the best care and service.

With a Fendt Tigo, you get a cutting edge product that will overcome the toughest of challenges. That's why you can expect that little bit extra when it comes to services from highly-efficient, certified Fendt dealers:

- Fast lines of communication between you and our trained service team.
- 24/7 availability of replacement parts throughout the season
- 12-month warranty on Fendt original parts and their fitting

**100% quality. 100% service: Fendt Services**  
We offer outstanding services to offer you the best possible reliability of use and efficiency from your Fendt Machine:

- Fendt Demo service
- AGCO Finance – finance deals
- Fendt Care – servicing and guarantee extensions



+44 330 123 9909

Your Fendt dealers are always there when you need them, and have just one aim – to make sure your Fendt machines are ready for action at any time. If something does go wrong during harvest time, simply call your certified service centre 24/7 on the emergency hotline.



FENDT SERVICES

# Rest assured that your machine will be ready for action tomorrow.

**Fendt Demo service**

Is this a new purchase? You'll love our Fendt solutions and overall efficiency. Let the Fendt Demo service make the decision easier.

**Individual finance models**

Investing in technology means a considerable capital outlay. A credit finance agreement from AGCO Finance offers attractive conditions and flexible terms. From the initial down payment to monthly instalments to the payment term – you set the general terms on which to finance your Fendt Tigo.

**Fendt Care – servicing and guarantee extensions**

To keep your machine ready for action at any time, we offer a tailored maintenance and repair service beyond the statutory warranty. This only covers the repair risk of a new machine for the first 12 months after delivery. That's where Fendt Care comes in. With flexible durations and flexible rates with and without excess, the machine can be guaranteed even after the first year. Your Fendt dealer will only install Fendt original parts. These have a proven standard of quality and are safety-tested. This ensures the best value retention for your Fendt machine.

Using the smartphone app "AGCO Parts Books to go", you can find Fendt spare parts quickly and easily and order them directly. The app is available for download in the app store and in the Google Play Store. Your personal access data is available from your Fendt dealer.

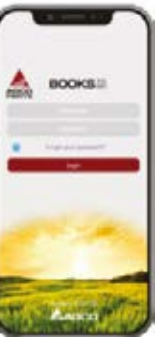

## Full control over costs and planning reliability

	Bronze	Silver	
Fendt Care <sup>1</sup>	Regular maintenance, fixed maintenance costs	Cover against the risk of repair (excludes wear)	
Benefits	Reliability of use	Full coverage under great conditions	Full protection while you keep costs under control
Regular maintenance	✓	✓	✓
Repair costs		✓	✓
Excess		€190	€0

<sup>1</sup> Applies only for Fendt Tigo XR and PR.



3 years /  
4,000 operating  
hours

With our new Fendt Care rates, Fendt offers extensive coverage for the reliability and repair risk of new machines. Fendt Care gives you complete cost control with exceptional service. Fendt has a flexible and tailored solution for your fleet.



Standard and optional equipment  
 Standard: ■  
 Optional: □

FENDT TIGO FORAGE WAGON (PR/XR)

# Equipment variants and technical details.



	TIGO 45 PR	TIGO 50 PR	TIGO 60 PR	TIGO 70 PR	TIGO 65 XR	TIGO 75 XR	TIGO 90 XR	TIGO 100 XR
<b>Drawbar</b>								
Hydropneumatic drawbar suspension	□	□	□	□	■	■	■	■
Articulating drawbar position control	□	□	□	□	□	□	□	□
<b>Pick-Up</b>								
Pick-up sensing roller in middle of wagon	□	□	□	□	□	□	□	□
Hydraulic pick-up relief	□	□	□	□	□	□	□	□
<b>Table/rotor</b>								
Channel cover	□	□	□	□	□	□	□	□
Cutterbar swingable to the side	□	■	■	■	■	■	■	■
Single knife protection	■	■	■	■	■	■	■	■
Central knife release	■	■	■	■	■	■	■	■
Knife sharpening system	□	□	□	□	□	□	□	□
<b>Loading space assembly</b>								
Multi-functional bulkhead	■	■	■	■	■	■	■	■
No feed roller	■	■	■	■	■	■	■	■
2 feed rollers	□	□	□	□	□	□	□	□
3 feed rollers	□	□	□	□	□	□	□	□
Lowered scraper floor 250 mm	■	■	■	■	■	■	■	■
2-speed scraper floor motor	□	□	□	□	■	■	■	■
Scraper floor gearbox protection	□	□	□	□	■	■	■	■
Loading space camera	□	□	□	□	□	□	□	□
Weighing system	□	□	□	□	□	□	□	□
Loading space cover**	□	□	□	□	□	□	□	□
3 LED work lights	□	□	□	□	■	■	■	■
2 additional LED reversing headlights	□	□	□	□	□	□	□	□
Loading space doors	■	■	■	■	■	■	■	■
<b>Chassis</b>								
Hydraulic forced steering	□	□	□	□	□	□	□	□
Electrical forced steering	□	□	□	□	□	□	□	□
Lift axle						□	□	□
<b>Operation</b>								
ISOBUS Fendt VarioTerminal (7"; 10.4")	■	■	■	■	■	■	■	■
Tigo Terminal (membrane keypad)	■	■	■	■	■	■	■	■
VarioFill automatic loading and unloading system	■	■	■	■	■	■	■	■
TIM throughput control					□	□	□	□
<b>Tyres</b>								
620/40 R22.5	□							
710/35 R22.5 Country	□							
710/40 R22.5 Flotation Pro		□	□	□				
710/45 R22.5 Flotation Trac		□	□	□				
710/50 R26.5 Flotation Pro			□	□	□	□	□	□
750/45 R26.5 Flotation Trac			□	□	□	□	□	□
750/45 R26.5 Alliance 380	□	□	□	□	□	□	□	□
750/45 R26.5 Alliance 380 - Tridem					□	□	□	□
800/45 R26.5 Flotation Pro			□	□	□	□	□	□
800/45 R30.5 Flotation Trac					□	□		

\*\* = Tyre-dependent

**Technical data**

		TIGO 45 PR	TIGO 50 PR	TIGO 60 PR	TIGO 70 PR	TIGO 65 XR	TIGO 75 XR	TIGO 90 XR	TIGO 100 XR
Volumes in accordance with DIN 11741	m³	31	31	36	41	38	44	50	54
Volumes in accordance with DIN 11741 with feed rollers	m³	29	29	34	39	36	42	48	52
Volumes in accordance with DIN 11741 without feed rollers	m³	32	32	37	42	38	44	50	54
Volumes with moderate compression	m³	45	50	60	70	65	75	90	100
Power requirement	kW/HP	96/130	96/130	110/150	125/175	132/180	147/200	169/230	184/250
Unladen weight	kg	6.650	7.100	7.600	8.100	9.200	10.200	11.900	12.300
Unladen weight with feed rollers	kg	7.050	7.550	8.050	8.550	9.700	10.700	12.400	12.800
Permissible overall weight*	kg	17.000/18.000	20.000/22.000	20.000/24.000	20.000/24.000	22.000/24.000	24.000/31.000	31.000	31.000
Overall width	m	2,52	2,52	2,52	2,52	2,55	2,55	2,55	2,55
Overall length	m	7,75	7,75	8,75	9,75	8,75	9,75	10,75	11,75
Overall length with feed rollers	m	8,38	8,38	9,38	10,38	8,75	9,75	10,75	11,78
Overall height	m	3,85	3,92	3,92	3,92	3,92	4,00	4,00	4,00
Loading area width	m	2,16	2,16	2,16	2,16	2,36	2,36	2,36	2,36
Loading area length	m	5,00	5,00	6,00	6,00	6,10	7,10	8,10	9,10
Track width	m	1,95	2,00	2,00	2,00	2,05	2,05	2,05	2,05
Permissible drawbar load	kg	2.000/3.000	2.000/4.000	2.000/4.000	2.000/4.000	4.000	4.000	4.000	4.000
Pick-up tine bar	Number	7	7	7	7	7	7	7	7
Pick-up operating width in accordance with DIN	cm	190/200	190/200	190/200	190/200	220	220	220	220
Tine spacing	mm	54	54	54	54	54	54	54	54
Pick-up ground clearance	cm	40-70	40-70	40-70	40-70	40-80	40-80	40-80	40-80
Rotor diameter	mm	800	800	800	800	800	800	800	800
Rotor tine rows	Number	7	7	7	7	7	7	7	7
Maximum number of knives	Number	40	40	40	40	45	45	45	45
Potential cutting length	mm	37	37	37	37	37	37	37	37
Maximum 40 km/h		□	□	□	□	□	□	□	□
Maximum 60 km/h*		□	□	□	□	□	□	□	□
18.5 t boogie tandem chassis 22.5		■							
22 t boogie tandem chassis 22.5			■	■	■				
24 t boogie tandem chassis 26.5				□	□				
24 t hydropneumatic tandem chassis with FSC 26.5				□	□	■	■		
24 t hydropneumatic tandem chassis with FSC 30.5						□	□		
31 t hydropneumatic tridem chassis with FSC 26.5								■	■
Hydraulic braking system		□	□	□	□	□	□	□	□
Compressed air brake system		□	□	□	□	□	□	□	□
Load-dependent braking system		■	■	■	■	■	■	■	■
Self-steering axle		□	■	■	■	■	■	■	■

\* = specific to the country



# FENDT

It's Fendt. Because we understand Agriculture.

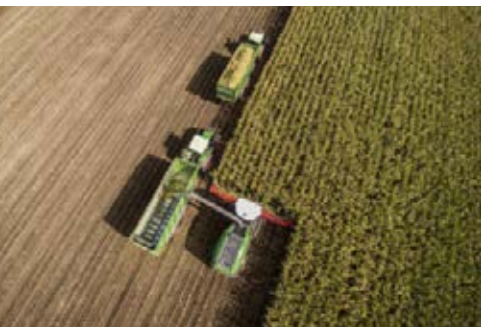

[www.fendt.com](http://www.fendt.com)

AGCO GmbH – Fendt Marketing  
87616 Marktberdorf, Germany

 **AGCO**  
Your Agriculture Company

Fendt is a worldwide brand of AGCO.  
All details regarding scope of delivery, appearance, performance, dimensions and weights, fuel consumption and running costs of vehicles reflect the latest information available at the time of print. These may change by the time of purchase. Your Fendt dealer will be happy to inform you about any changes. The vehicles shown do not feature country-specific equipment.