



MASSEY FERGUSON

2021 | MF TD SERIES

Latest Generation of High Output Tedders



FROM MASSEY FERGUSON

MFTD SERIES



Page 04
Massey Ferguson TD Series Tedders



Page 06
Forage quality features



Page 07
Best harvest - fast and low-impact

Contents

- 04 Massey Ferguson TD Series Tedders
- 06 Quality features
- 07 Best harvest - fast and low-impact
- 08 MF Hay tedders with transport chassis
- 10 MF TD X Series Tedders
- 12 Performing features
- 14 Specifications



Page 08
MF Hay Tedders with
transport chassis

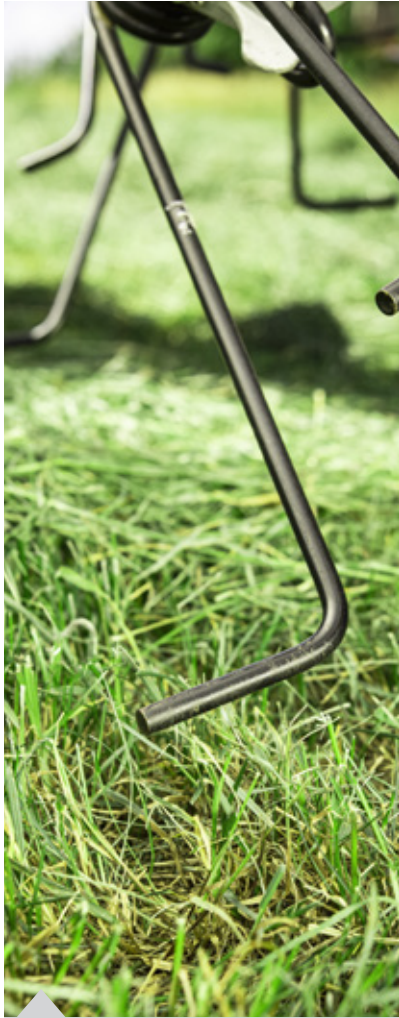

Page 10
MF TD X Series

Massey Ferguson TD Series Tedders

When it comes to drying hay, it's nearly impossible to beat Mother Nature. Of course, farmers have utilised nature's resources – like the wind and sun – for as long as seeds have been planted in the ground. Today, you can assist Mother Nature's gifts by spreading the crop with a professional-grade Massey Ferguson TD Series tedder.

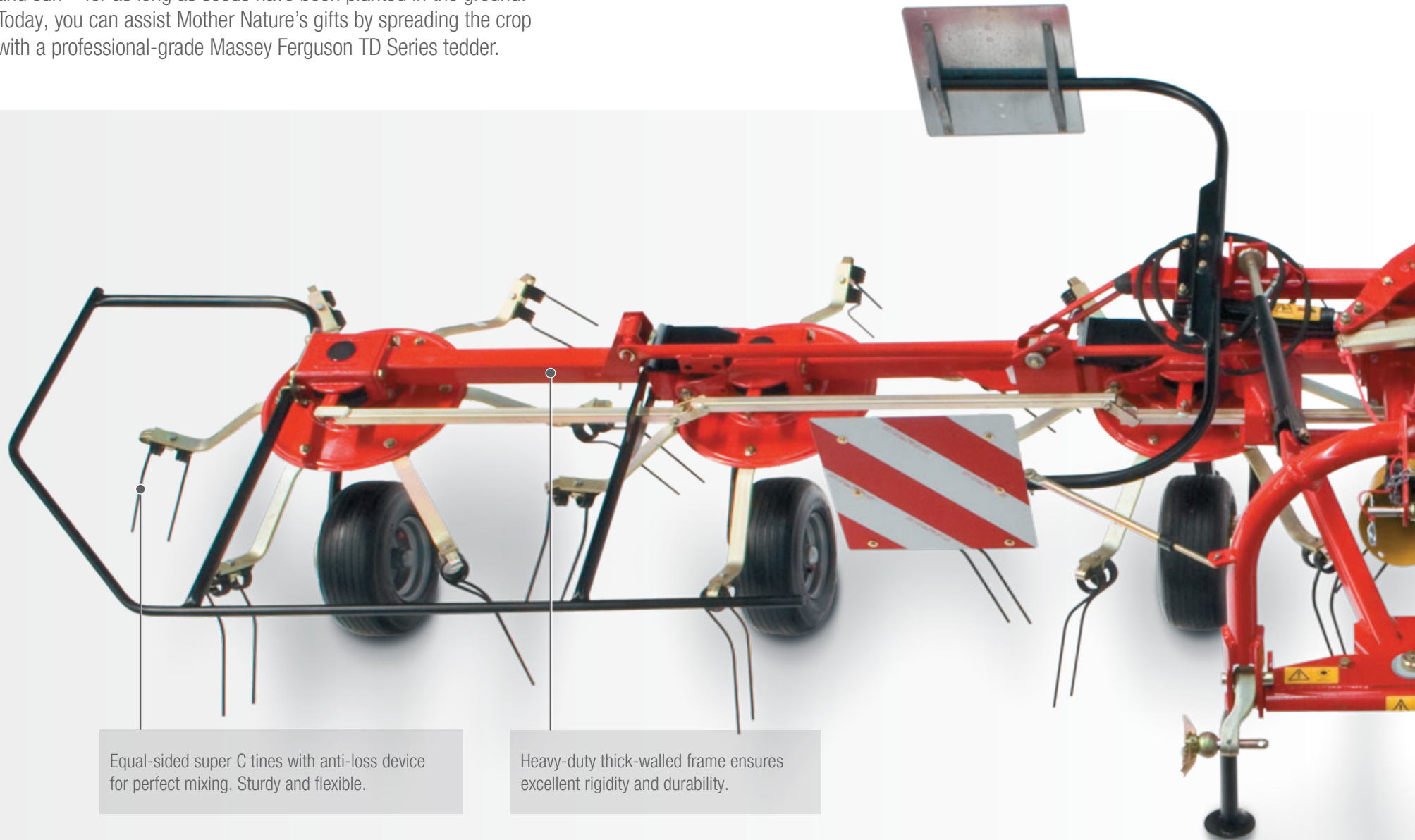

Equal-sided super C tines with anti-loss device for perfect mixing. Sturdy and flexible.

Heavy-duty thick-walled frame ensures excellent rigidity and durability.

15 MF models provide tedding widths from 4.5 metres to 12.70 metres. Each one offers easily adjusted spreading angles of 15, 18 and 20.5 degrees for adaptability to all forage and crop conditions.

All MF models are simple to set-up and adjust for quick and efficient ground coverage. MF TD 454, MF TD 524, MF TD 676, MF TD 776, MF TD 868 DN and MF TD 1110 DN models also feature synchronised lifting of exterior rotors via a centralised hydraulic lift system and pressure cylinders to ensure optimum performance and eliminate one-sided loads – even on slopes.

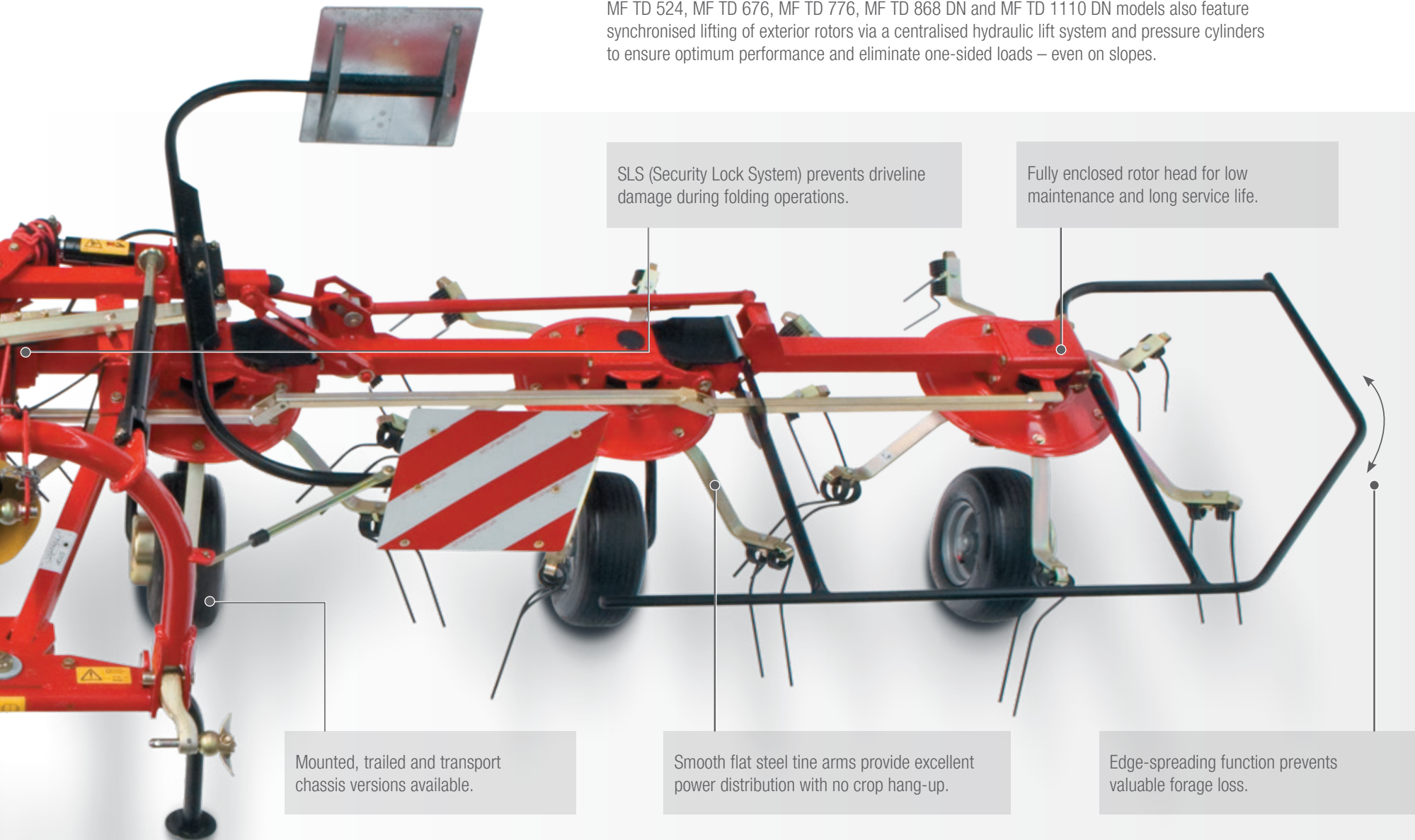

SLS (Security Lock System) prevents driveline damage during folding operations.

Fully enclosed rotor head for low maintenance and long service life.

Mounted, trailed and transport chassis versions available.

Smooth flat steel tine arms provide excellent power distribution with no crop hang-up.

Edge-spreading function prevents valuable forage loss.

Quality features

MF Tedders with Three-point linkage

Versatile high performance MF tedders, thanks to the excellent quality of work they produce and their flexibility of use.



MF Tedders with transport chassis

MF Hay tedders for fast and safe travel – compact on the road, wide coverage out in the field.



Rotor Head

Massey Ferguson rotor heads have an enclosed design which protects all important components from dirt and dust. This design provides years of trouble-free service.

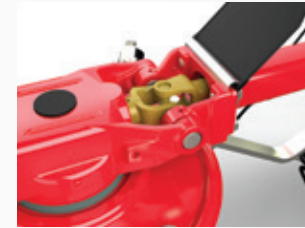

Power Train

The individual rotors are driven via a generously dimensioned hexagonal shaft and robust universal joints. This type of power transmission is smooth and reliable and free from backlash.



Frame

All MF hay tedders are equipped with thick-walled, strongly dimensioned square frame tubes which ensure excellent rigidity and a very long service life. The individual rotor frames are connected via sturdy frame joints with special flange sleeves and hardened pins. All joints can be relubricated for extra reliability and durability. This contributes to ensuring optimum performance even after many years of service.

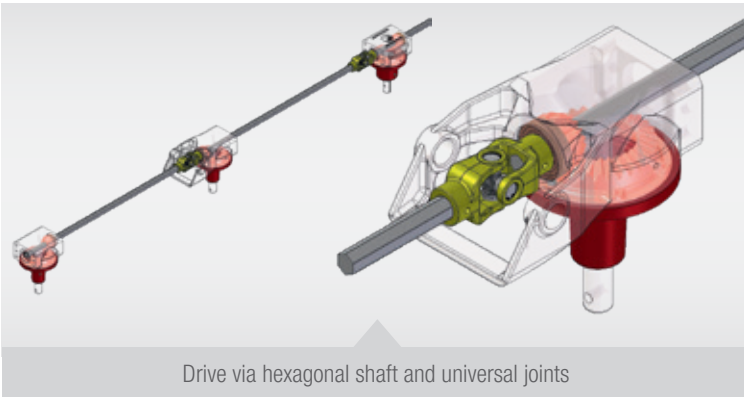

MF TD SERIES

Best harvest – fast and low-impact

Comb effect – only with equal-sided tines

Only equal-sided tines allow you to achieve an optimum mixing of your high-quality forage. This is known as the comb effect since, during the process, the different layers of forage are perfectly mixed together and turned, providing the optimum production of high-quality forage.

Tines with sides of equal length also provide the benefit that you do not need right-hand and left-hand tines but only one kind of tine, which makes spare parts management easier.

Tine arms

The tine arms are made of a tough, galvanised flat steel bar, which allows a wide contact surface between tine and rotor disc. This ensures excellent power transmission even under the harshest of working conditions. The forces are optimally absorbed whenever the ground is uneven.

All Massey Ferguson tedders are equipped with tine loss protection as a standard feature. This protects machines which are following behind and also your valuable livestock. The tines are secured under the tine arm. This arrangement has the advantage that the upper side is smooth and, as a result, forage will not be left hanging. It also allows the tine greater freedom of movement, which contributes to optimal processing of your high-quality forage.



Transport position



Wide contact surface for optimum power transmission

Super C – The quality feature

The Super C quality feature guarantees a high level of quality and ensures an extremely long service life. The tines used at Massey Ferguson have to undergo a test cycle and survive 200,000 impacts without damage. Special process steps are used to design and manufacture the tines for toughness, elasticity and durability.

The Super C tine has a tine diameter of 9.5 mm, a coil diameter of 70 mm and six windings, making it one of the most efficient on the market and typical of the high quality of each and every Massey Ferguson hay tedder.



9.5 mm tine diameter



6 windings



70 mm coil diameter



Massey Ferguson Super C quality tines

MF Tedders with transport chassis

MF TD 776 TRC, MF TD 868 TRC, MF TD 1008 TRC, MF TD 1310 TRC

Transport Chassis

The MF TD 776 TRC, MF TD 1008 TRC and MF TD 1310 TRC are tedders that can be conveniently attached via the drawbar of the tractor, and the MF TD 868 TRC can be attached to the lower links. With working widths from 7.70 metres to 12.7 metres, you can easily handle any area of grassland – no matter how big. The wide transport chassis and the compact transport position ensure safe and time-saving travel from field to field – ideal for completing the job in the face of worsening weather or other time constraints.

Security comes first

Thanks to the SLS (Security Lock System) from Massey Ferguson, maximum safety for your machine is guaranteed during folding operations. SLS is an automatic, hydraulically-activated switch-off and positioning system, with integrated freewheel which interrupts the flow of power to the rotors when the halves of the machine are folded up. As a result, a high degree of safety is ensured in the transport position as well as during maintenance work. The possibility of damage to the power train is also minimised in the event of incorrect operation.

Convenience of operation which speaks for itself

The rotors are easily folded in and out by a hydraulic sequential control system operated directly from the tractor seat.

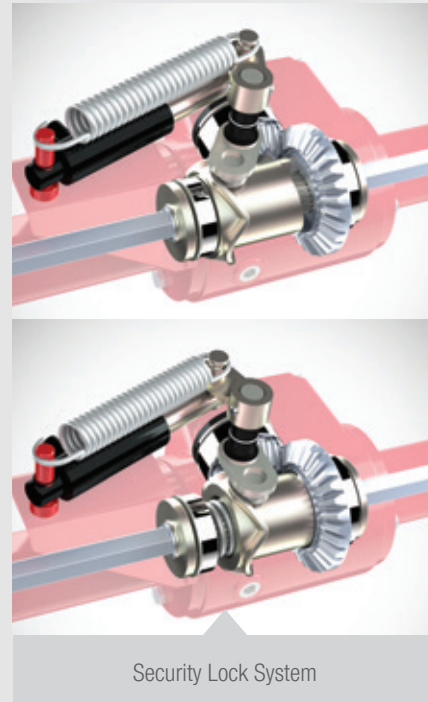

MF TD SERIES

Perfect working conditions

As with all Massey Ferguson hay tedders, the forage is picked up by the tines and turned gently, without damage. A light, loose and well mixed mat of forage is created, to help ensure a top quality end-product. With the central edge spreading device, which is fitted as standard on MF TD 776/868 TRC, edges of fields no longer present any problems. It's all high quality forage down to the last blade of grass. Because of the spreading angle adjustment system, you can always adapt your machine according to the harvesting situation. In the working position, the transport chassis is folded up in front of the rotors, which ensures an optimum centre of gravity.

As a result, the chassis does not stand in the ejection path of the forage and the loading created by the centre rotors is reduced to a minimum – perfect pre-requisites for producing your high quality forage.



Tines with equal sides with comb effect



MF TD X Series Tedders

MF TD 776 X DN, MF TD 1028 X TRC, MF TD 1310 X TRC

Massey Ferguson TD X tedders benefit from the renowned design of the well-proven Lotus range. There are three models – one mounted and two trailed transport chassis versions. All models deliver:

- High output even in the heaviest crop conditions
- Faster drying times in short weather windows
- Optimum forage quality

Hook Tines

Tedding with proven hooked, long and short tines reduces drying times. This is thanks to the unique hooked tines moving 50% more material on each rotor revolution. At the same time the longer tine rotates 12% faster than the short one, throwing wetter material further.

Gentle and Efficient

Innovative design ensures TD X tedders perfectly follow ground contours, preventing damage to the sward while eliminating forage contamination. The optimum rotor speed is achieved at a PTO speed of just 400-450 rpm. This also saves fuel as well as greatly reducing crop losses and damage.

Low Maintenance and Long life

MF TD X Series tedders are mounted to a strong frame and feature a heavy duty driveline. Each rotor is driven by a large shaft and universal joints for maximum durability to minimise downtime.



MF TD X TRC

MF TD X SERIES



Hook Tines

High capacity, gentle spreading for faster drying

Unique Hook Tine

Hooked tines lift and separate the crop more easily

- This delivers 50% more capacity on each rotor revolution
- Gentle operation
- Minimises sward damage and crop contamination

Coils provide optimum flexibility

- Gentle, even spreading
- Less wear and lower risk of breakage

Superb spreading from short and long tines

- Long tines rotate 12% faster than short ones to enhance spreading
- Slower moving, short tines lift the drier crop, which is on the top, and throw it a shorter distance
- The longer tines lift the wetter, heavier crop off the ground and throw it on top of the lighter, drier crop where it dries faster

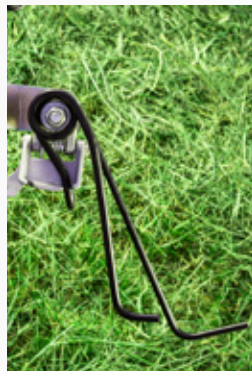
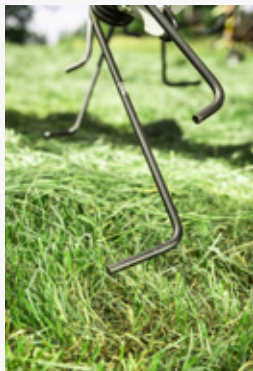

Headland spreading

A simple tine adjustment prevents the crop being thrown into a hedge or ditch when spreading on headlands. This throws the crop away from the edge, evenly distributing it over the ground crop.

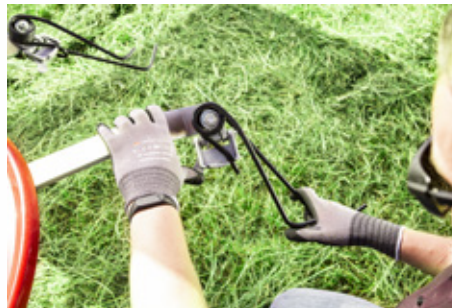

Simple working height adjustment



Performing features



Transport mode: For road transport, the rotors are placed on the frame. This protects the pivot joints, as there is no stress on them at all when they are folded in. The special transport position, with the rotors lined up in a row, means that even the larger MF TD X models are compact enough for transport.



The grid frame assures the protection and reinforces the main frame.

MF TD X SERIES



The 5 spreading angle settings are adjusted as easily as moving a pin, to meet your precise needs.



Anti-wrapping system to avoid crop around the wheel axle.



Large rotor provides you with a high speed at low rotor speed.



Outstanding maneuverability despite large working width.



MF TD X SERIES



Low cost of ownership and easy maintenance thanks to the maintenance-free double-cross joints and easy access to pivot greasers and oil filled gearbox.

Specifications

Three-point linkage

Model	MF TD 454 DN	MF TD 524 DN	MF TD 676 DN	MF TD 776 DN	MF TD 868 DN	MF TD 1110 DN
Mounting category	Cat. I and II	Cat. I and II	Cat. I and II	Cat. I and II	Cat. I and II	Cat. I and II
Working width approx. m	4.50	5.20	6.60	7.70	8.60	10.7
Transport width approx. m	2.65	3.00	2.90	3.00	2.90	3
Parking height approx. m	2.40	2.60	3.30	3.65	3.30	3.3
Rotors	4	4	6	6	8	10
Tine arms per rotor	6	6	6	6	6	6
Anti-tine loss protection	●	●	●	●	●	●
Tyres	16 / 6.50 - 8	16 / 6.50 - 8	16 / 6.50 - 8	6 x 16 / 6.50 - 8	6 x 16 / 6.50 - 8	8 x 16 / 6.50 - 8
					2 x 18.5 / 8.50 - 8	2 x 18.5 / 8.50 - 16
Power demand approx. kW/hp	22/30	22/30	30/41	60/82	70/95	88/120
Hydraulic outlets	1 x SAV	1 x SAV	1 x SAV	1 x SAV	1 x SAV, 1 x DAV*	1 x SAV, 1 x DAV*
PTO rpm	540	540	540	540	540	540
PTO shaft	Overload (radial pin clutch)	Overload (radial pin clutch)	Overload (radial pin clutch)	Overload safety clutch (radial pin clutch)	Overload safety clutch (radial pin clutch)	Overload safety clutch
Warning panels	●	●	●	●	●	●
Electrical lighting	○	○	○	○	○	●
Weight approx. kg	574	606	822	946	1,172	1,535

Three-point linkage ALPINE

Model	MF TD 434 DN	MF TD 576 DN
Mounting category	Cat. I and II	Cat. I and II
Working width approx. m	4.3	5.7
Transport width approx. m	2.44	2.55
Transport length approx. m	2.36	3
Rotors	4	6
Tine arms per rotor	6	5
Anti-tine loss protection	○	○
Rotor tyres	15 / 6.00 - 6	15 / 6.00 - 6
Power demand approx. kW/hp	22/30	25/34
Hydraulic outlets	1 x SAV	1 x SAV
PTO rpm	540	540
PTO shaft	Overload safety clutch	Overload (radial pin clutch)
Warning panels	●	●
Electrical lighting	○	○
Weight approx. kg	385	498

Transport Chassis

Model	MF TD 776 TRC	MF TD 868 TRC	MF TD 1008 TRC	MF TD 1310 TRC
Mounting category	Drawbar	Cat. II (lower links)	Drawbar**	Drawbar**
Working width approx. m	7.7	8.6	10.2	12.7
Transport width approx. m	3.0	3.0	2.94	2.94
Transport length approx. m	4.48	4.4	5.7	5.7
Rotors	6	8	8	10
Tine arms per rotor	6	6	6	6
Anti-tine loss protection	●	●	●	●
Rotor tyres	4 x 16 / 6.50 - 8	6 x 16 / 6.50 - 8	6 x 16 / 6.50 - 8	8 x 16 / 6.50 - 8
	2 x 18.5 / 8.50 - 8	2 x 18.5 / 8.50 - 8	2 x 18.5 / 8.50 - 8	2 x 18.5 / 8.50 - 8
Chassis Tyres	215/65-16	10.0 / 80-12	10.0 / 75-15.3	10.0 / 75-15.3
Power demand approx. kW/hp	30/41	40/54	40/54	66/90
Hydraulic outlets	1 x SAV	1 x DAV*	1 x SAV, 1 x DAV*	1 x SAV, 1 x DAV*
PTO rpm	540	540	540	540
PTO shaft	Overload safety clutch (radial pin clutch)	Overload safety clutch (radial pin clutch)	Overload safety clutch (friction clutch)	Overload safety clutch (friction clutch)
Warning panels	●	●	●	●
Electrical lighting	●	●	●	●
Weight approx. kg	1,237	1,660	1,860	2,160

Three-point linkage TD X Series

Model	MF TD 776 X DN	MF TD 1028 X TRC	MF TD 1310 X TRC
Configuration	3 point linkage	Trailed (lower links)	Trailed (lower links)
Mounting category	Cat. II	Cat. II	Cat. II
Working width approx. m	7.7	10.2	12.5
Transport width approx. m	2.95	3	3
Transport length approx. m	2.2	5.2	6.7
Rotors	6	8	10
Tine arms per rotor	6	7	7
Anti-tine loss protection	●	●	●
Tyres	6 x 16 / 6.50 - 8	8 x 16 / 6.50 - 8	10 x 16 / 6.50 - 8
Tyres of transport chassis	-	380 / 55 - 17	380 / 55 - 17
Power demand approx. kW/hp	55/75	40/54	66/90
Hydraulic outlets	1 x DAV*	2 x DAV*	2 x DAV*
PTO rpm	540	540	540
PTO shaft	With Overload protection	With Overload protection	With Overload protection
Warning panels	●	●	●
Electrical lighting	○	●	●
Weight approx. kg	1,030	2,280	2,950

- Not available/not applicable

● Standard specification

○ Optional

* DAV with float position

** Delivery of the machine ex works without towing drawbar.

Please always observe the rules and regulations for connection equipment between tractor and machine which are applicable in your respective country or region.

Illustrations show some of the special equipment. Some machines available in selected countries only. The images provided do not necessarily correspond to the most recent version of standard equipment.



MASSEY FERGUSON

A world of experience. Working with you.

www.MasseyFerguson.com

 www.facebook.com/masseyfergusonGlobal

 [Twitter.com/MF_EAME](https://twitter.com/MF_EAME)

 [Instagram.com/MasseyFergusonGlobal](https://www.instagram.com/MasseyFergusonGlobal)

 www.YouTube.com/MasseyFergusonGlobal



MASSEY FERGUSON® is a worldwide brand of AGCO.
© AGCO SAS. 2020 | A-A-17092 | English



Responsible forest management